



## Specifications

Electrical Ratings	3A @ 120VAC 1A @ 250VAC See Contact Options	Dielectric Strength	1500Vrms min
Electrical Life	50,000 cycles typical	Insulation Resistance	>100MΩ min
Contact Resistance	<20mΩ initial @ 2-4VDC, 100mA	Operating Temperature	-40°C to 85°C
Actuator Travel	0.85mm ± 0.2mm	Storage Temperature	-40°C to 85°C

## Materials

Actuator	6/6 Nylon, Glass Filled
Housing	Diallyl Phthalate (DAP)
Cover	Stainless Steel
Bushing	Brass, Nickel Plated
Contacts	Brass, Silver Plated
Terminals	Brass, Silver Plated

## Ordering Information

1. Series	ANP	2	1	F4	C	Q	E	C742
ANP								
2. Number of Poles								
1 = SPDT								
2 = DPDT								
3. Switch Function								
1 = ON - (ON)								
2 = ON - ON Latching								
4. Bushing								
F4 / N4 = ¼-40 UNS-2A / Non-threaded, keyway, 6.35mm								
F9 / N9 = ¼-40 UNS-2A / Non-threaded, flat, 6.35mm								
**No bushing is selected if a panel mount frame is selected below								
5. Terminals								
B = Solder Lug								
C = PC pin								
D = Quick connect								
H = Horizontal mount, right angle PC pin; HS = Snap In not available with DPDT								
V = Vertical mount, right angle PC pin								
S20 = PC pin with support bracket; V20 = Snap in support bracket								
S25 = PC pin with support bracket								
S40 = PC pin with support bracket								
6. Contacts								
Q = Silver plated								
R = Gold plated								
G = Gold over Silver plated								
7. Epoxy Seal								
E = Epoxy Seal								
8. Actuator Cap / Frame								
Blank = None								
C73								
C74								
C75								
C76								
C77								
				F75 = Snap in panel mount with frame <i>only available with momentary option</i>				
				F76 = Snap in panel mount with frame <i>only available with momentary option</i>				

## Miniature Pushbutton

### Switch Function



SPDT

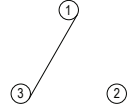

Momentary

Function	Pushbutton Position	
1	ON	(ON)
Terminals	1-3	1-2

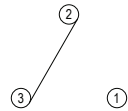
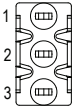
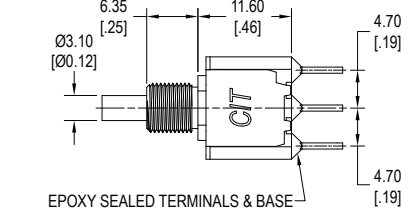
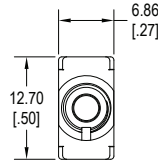

Latching

Function	Pushbutton Position	
2	ON	ON
Terminals	2-3	2-1

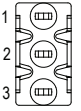
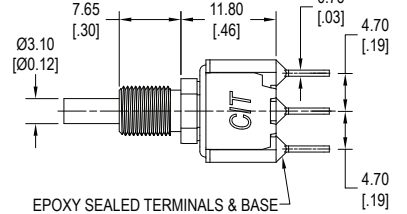
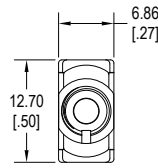

DPDT

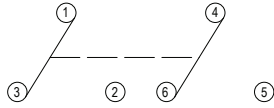

Momentary

Function	Pushbutton Position	
1	ON	(ON)
Terminals	1-3 4-6	1-2 4-5

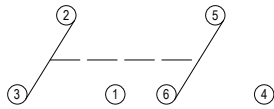
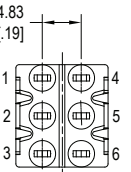
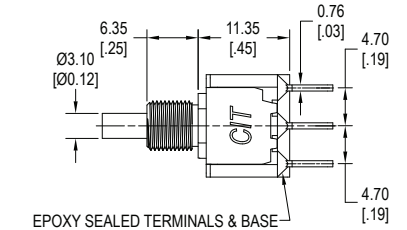
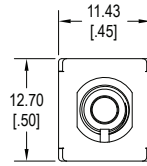

Latching

Function	Pushbutton Position	
2	ON	ON
Terminals	2-3 5-6	2-1 5-4

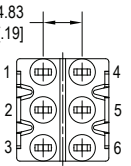
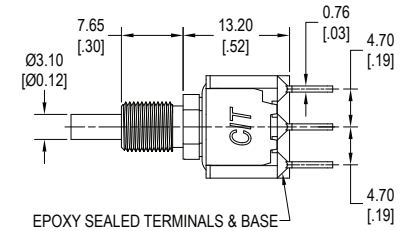
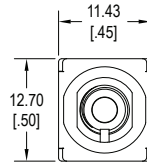

### Panel Mounting

Keyway without locking ring

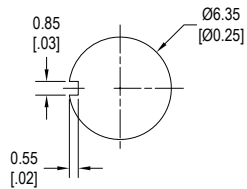

Flat without locking ring

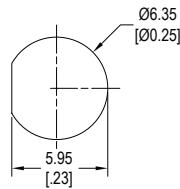

With locking ring

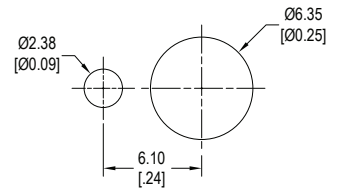

## Bushing Options

Note: Actuator Height for H, V, S20-S40 and V20-V40 terminal options is subtracted by 0.5 mm

### F4 Threaded

#### Keyway, momentary

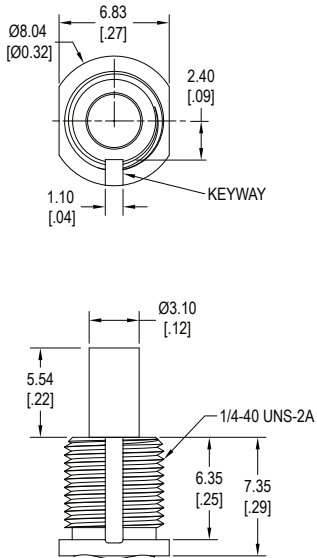

#### Keyway, latching

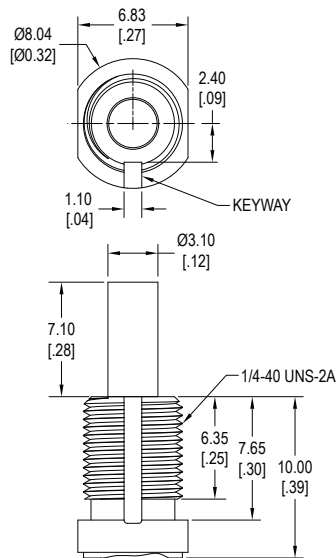

### F9 Threaded

#### Flat, momentary

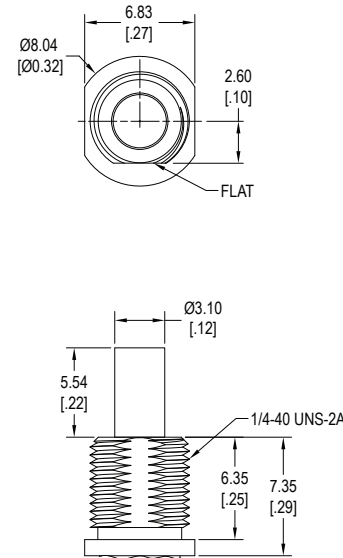

#### Flat, latching

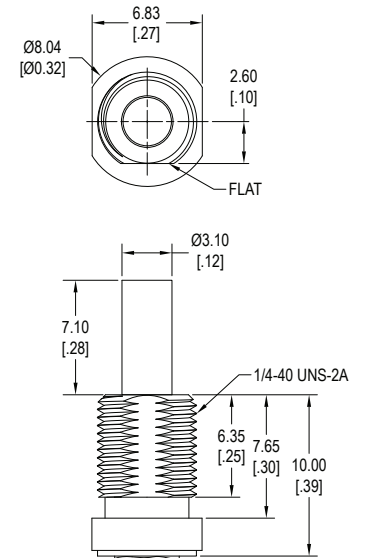

### N4 Non-Threaded

#### Keyway, momentary

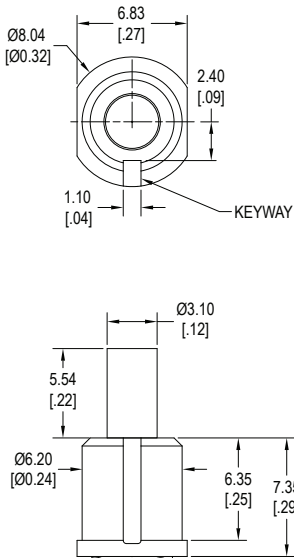

#### Keyway, latching

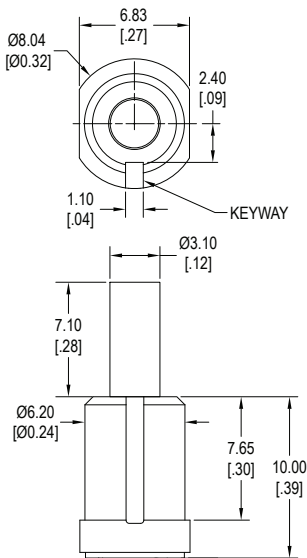

### N9, Non-Threaded

#### Flat, momentary

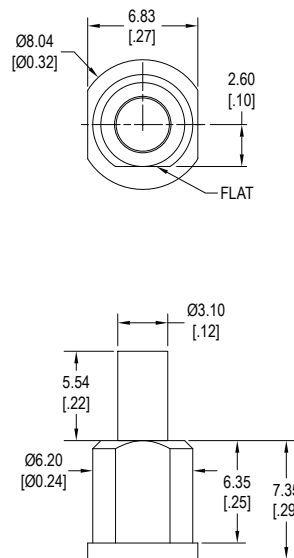

#### Flat, latching

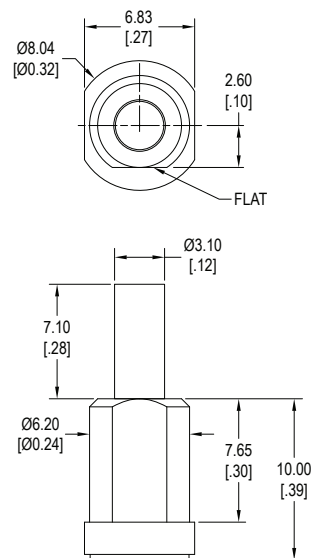

**Terminal Options**

**B, Solder Lug**  
0.76 (0.3) Terminal Thickness

Momentary

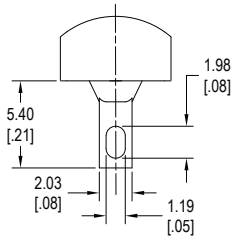

Latching

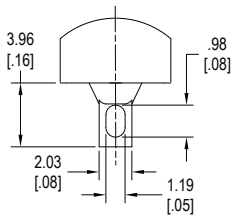

**C, PC Pin**  
0.76 (0.3) Terminal Thickness

Momentary

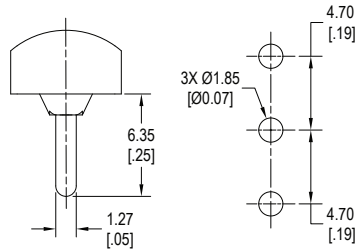

Latching

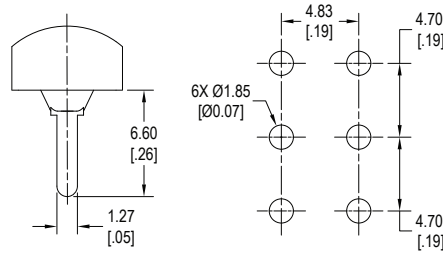

**D, Quick Connect**  
0.76 (0.3) Terminal Thickness

Momentary

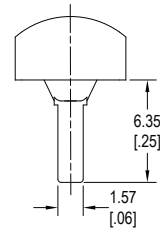

Latching

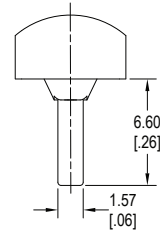

**H, (HS, snap-in bracket), horizontal mount, right angle PC pins, single pole**

Momentary

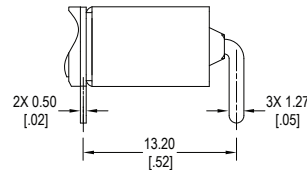
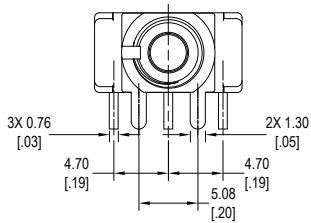

SPDT, momentary

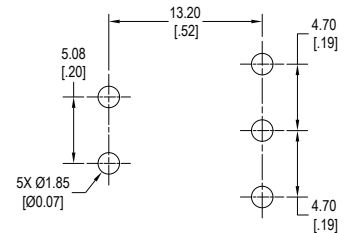

Latching

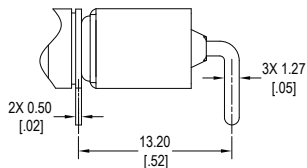
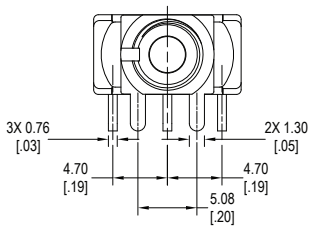

## Terminal Options

H, horizontal mount, right angle PC pins, double pole

Momentary

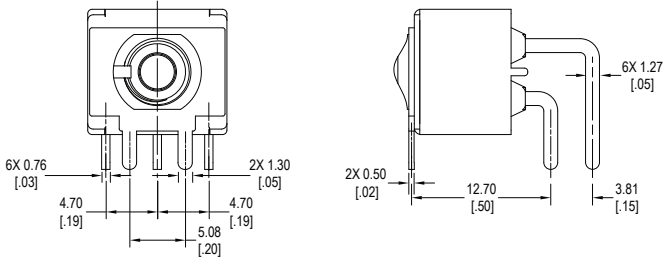

DPDT, momentary

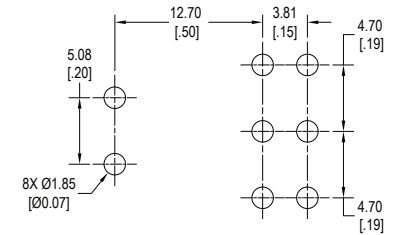

Latching

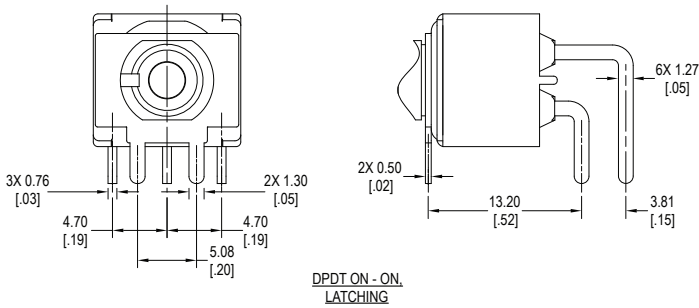

DPDT, latching

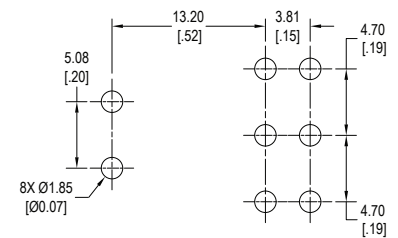

V, vertical mount, right angle PC Pins, single pole

Momentary

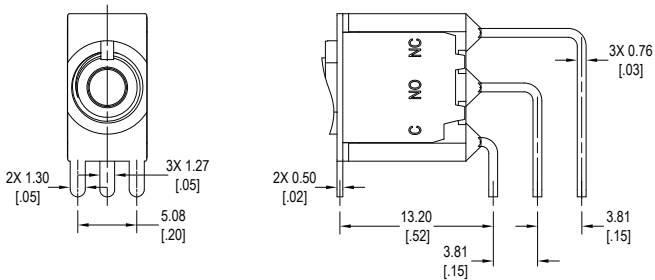

SPDT

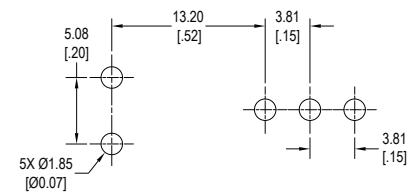

Latching

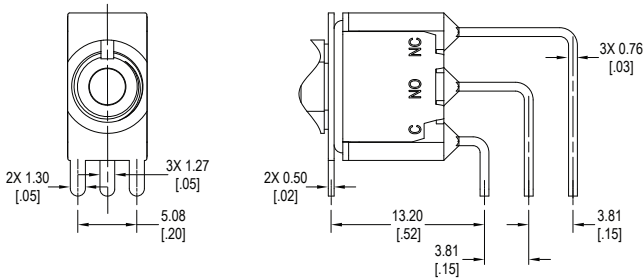

## Terminal Options

V, vertical mount, right angle PC pins, double pole

Momentary

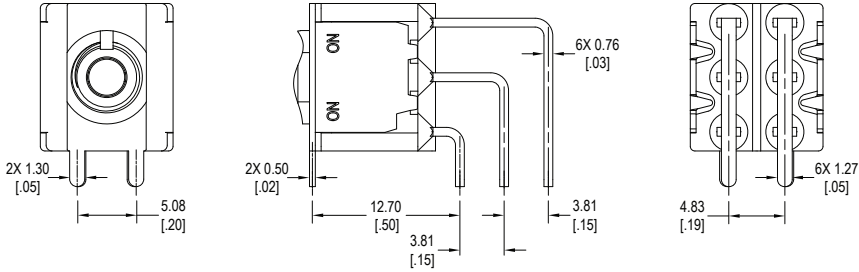

DPDT, momentary

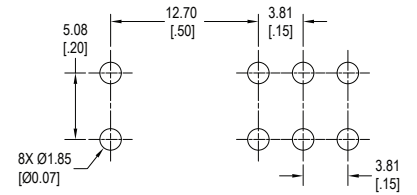

Latching

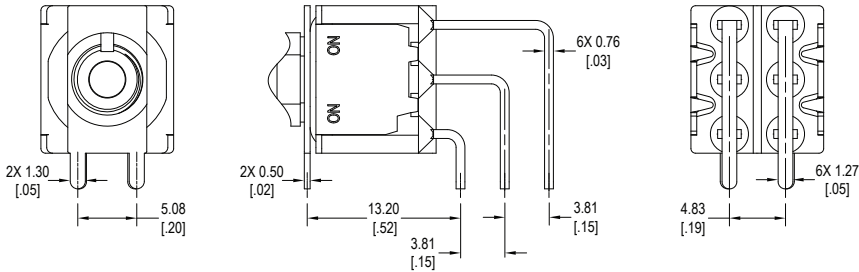

DPDT, latching

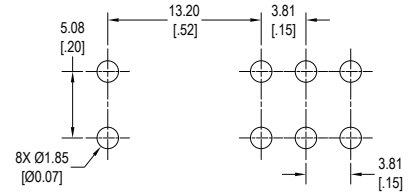

S20/S25 (V20, snap-in bracket), PC pins with support bracket

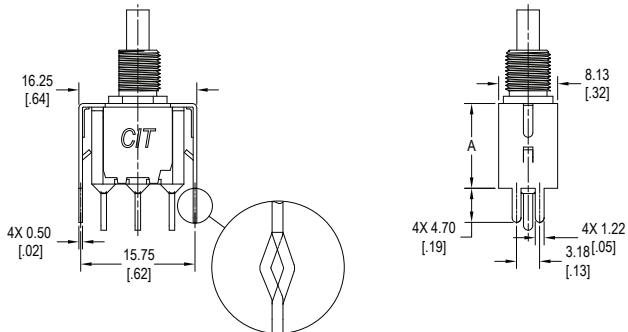

SPDT

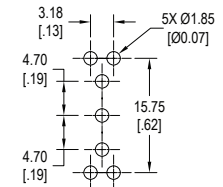

DPDT

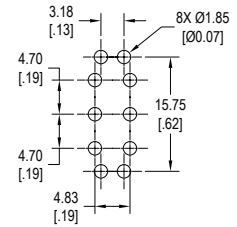

Terminal Option	"A" Dimension
S20 / V20	11.68
S25	16.00

## Terminal Options

S40, PC pins with support bracket

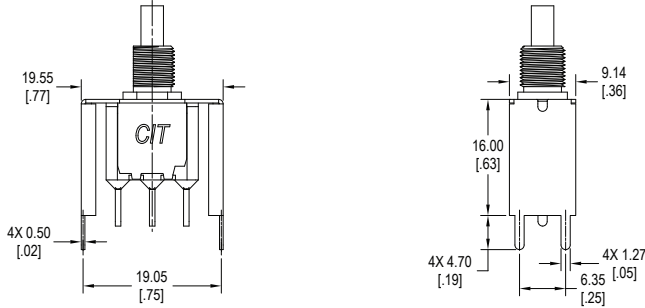

SPDT

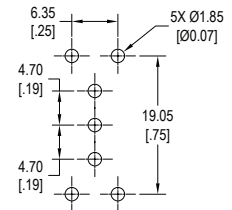

DPDT

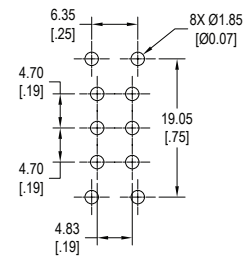

## Contact Options

Designator	Contact Material	Terminal Material	Electrical Ratings
Q	Silver Plating	Silver Plating	3A @ 120VAC; 1A @ 250VAC
R	Gold over Nickel Plating	Gold over Nickel Plating	0.4VA max @ 20VAC or VDC max
G	Gold over Silver Plating	Gold over Silver Plating	0.4VA max @ 20VAC or VDC max or 3A @ 120VAC; 1A @ 250VAC

## Cap Options Contact Factory for other available colors

C73\_

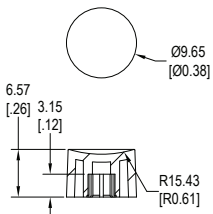

1 = White, 2 = Black, 3 = Red

C74\_

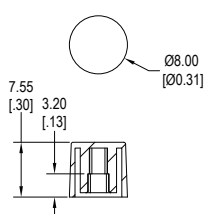

1 = White, 2 = Black, 3 = Red

C75\_

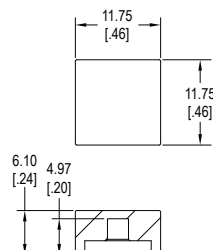
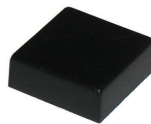

1 = White, 2 = Black, 3 = Red

C76\_

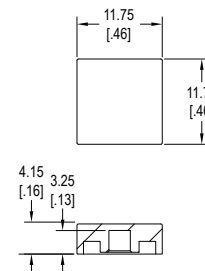
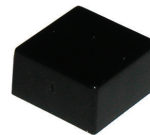

1 = White, 2 = Black, 3 = Red

C77\_

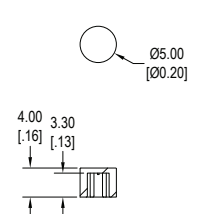

1 = White, 2 = Black, 3 = Red

**Frame Options** Contact Factory for other available colors

NOTE : Increase the length dimension to 15.75 / 15.88 for 1.5 / 3.2 thick panels

F75\_\_ ← Insert cap and frame colors here

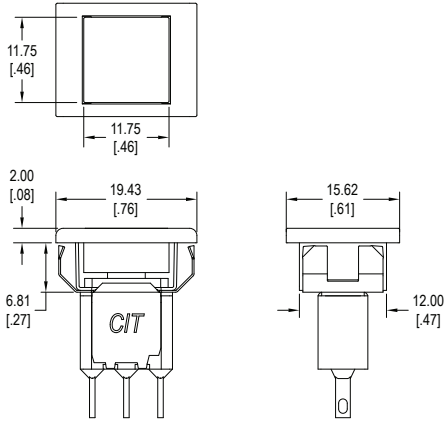

Cap Color / Frame Color  
1 = White, 2 = Black, 3 = Red

F76\_\_ ← Insert cap and frame colors here

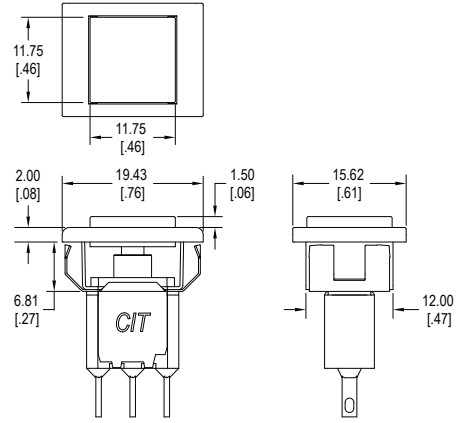

Cap Color / Frame Color  
1 = White, 2 = Black, 3 = Red

**Hardware** Two hex nuts, one lock washer & one locking ring supplied standard with threaded bushings

Hex Nut

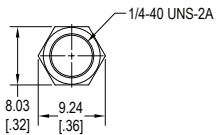
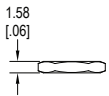

For use with F4 & F9 Bushing

Lock Washer

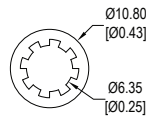
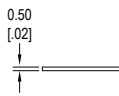

For use with F4 & F9 Bushing

Flat Locking Ring

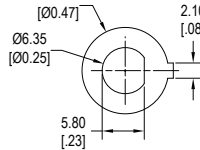
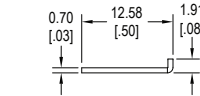

For use with F4 & F9 Bushing

Keyway Locking Ring

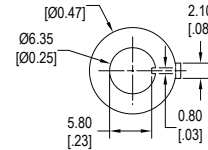
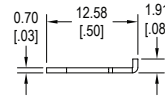

For use with F4 & F9 Bushing

Dress Nut

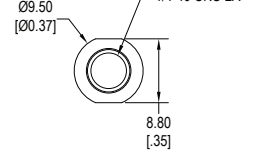
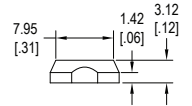

For use with F4 & F9 Bushing

Knurled Nut, 1.5mm

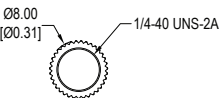
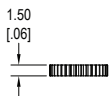

For use with F4 & F9 Bushing

Knurled Nut, 4.5mm

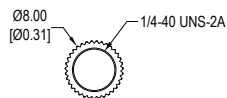
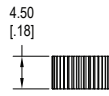

For use with F4 & F9 Bushing

Cap Shroud A

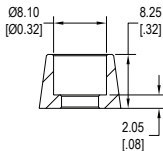
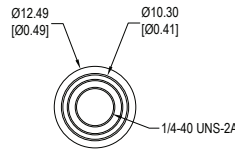

For use with F4 & F9 Bushing

Cap Shroud B

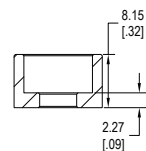
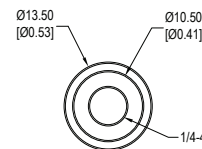

For use with F4 & F9 Bushing

Cap Shroud C

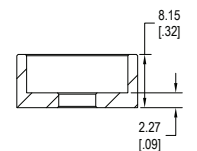
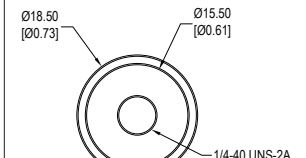

For use with F4 & F9 Bushing